

SPECIFICATION

- FREQ. RANGE: 10.0GHz--15.0GHz
- VSWR: ≤ 1.10
- INSERTION LOSS: ≤ 0.10 dB
- ISOLATION: ≥ 60 dB
- SWITCHING TIME: ≤ 50 ms
- VOLTAGE: 24 VDC, DURATION ≥ 50 ms
- CURRENT: ≤ 625 mA@ (24 VDC, 25°C)
- WORKING TEMPERATURE: -40°C--70°C
- LIFE: 100,000 CYCLES
- CONTROL MODE: LATCHING, MANUAL/ELECTRIC

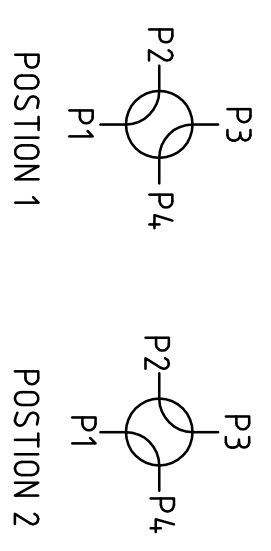
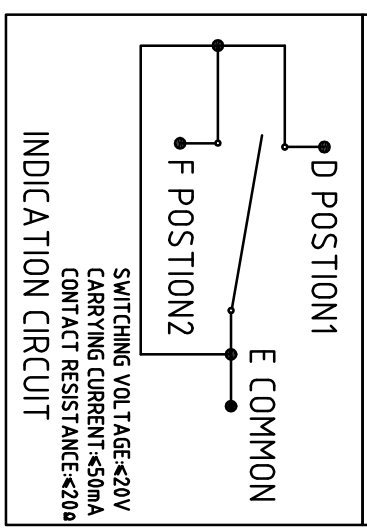
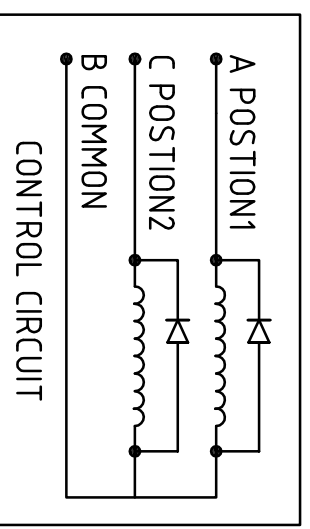

EXCITATION AND SWITCH STATUS
A VDC, B GND; D-E CONNECTED; POSITION 1
C VDC, B GND; F-E CONNECTED; POSITION 2

Model:FBP120DB2401

BJ120(WR75) WAVEGUIDE SWITCH